

Tympanoplasty Prostheses

Cartilage Preparation Instruments



KURZ Precise
Cartilage Knife Set



Cartilage Punch Set

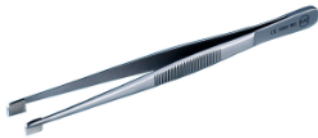

Cartilage Forceps Schimanski Design



HEINZ KURZ GMBH
TUEBINGER STR. 3
72144 DUSSLINGEN
GERMANY

Table of Contents

1 About this Document	3	7.6	Expected Lifetime	6
1.1 Symbols Glossary	3	7.7	Intended Place of Use	7
1.2 Safety Information Marking.....	3	8 Expected Clinical Benefit	7	
1.3 Additional Information	3	9 Possible Complications and Side Effects	7	
1.4 Safety-related Changes.....	3	10 Combining with Other Procedures	7	
2 Important Safety Information	4	11 Shelf Life and Storage	7	
3 Product Codes / REF	4	12 Processing	7	
4 Scope of Delivery	4	13 Application Instructions	7	
5 Packaging and Sterility	4	13.1 KURZ Precise Cartilage Knife	7	
6 Product Description	4	13.1.1 Create cartilage graft with a defined thickness.....	7	
6.1 General Information.....	4	13.1.2 Pressing the Fascia.....	10	
6.1.1 KURZ Precise Cartilage Knife Set.....	4	13.2 Cartilage Forceps Schimanski Design: Holding the Cartilage	11	
6.1.2 Cartilage Punch Set.....	5	13.3 Cartilage punch: Creating a Cartilage Shoe	11	
6.1.3 Cartilage Forceps Schimanski Design	5	14 Disposal	12	
6.2 Structure and Operation.....	5	15 Warranty	12	
6.3 Materials	5	16 Specifications	13	
6.4 Accessories	5	16.1 KURZ Precise Cartilage Knife	13	
6.5 Other Devices to be Used in Combination with the Device	5	16.1.1 KURZ Precise Cartilage Knife Set.....	13	
7 Intended Use	6	16.1.2 Accessories, Disposable Materials and Spare Parts	13	
7.1 Intended Purpose.....	6	16.2 Cartilage Forceps Schimanski Design	13	
7.2 Indications.....	6	16.3 Cartilage Punch	13	
7.3 Contraindications	6	16.3.1 Cartilage punch set	13	
7.4 Patient Target Group	6	16.3.2 Spare Parts	14	
7.5 Intended User	6			

1 About this Document

1.1 Symbols Glossary

















Symbol	Description
	Caution: Consult Instructions for Use
	Do not use if package is damaged
	Keep away from direct sunlight
	Keep dry
	Sterilized using irradiation
	Do not reuse
	Do not resterilize
	Single sterile barrier system
	Medical device
	Catalog number
	Batch code
	Unique Device Identification (UDI)
	Quantity per packaging unit
	Manufacturer
	Date of manufacture
	(USA) Caution: Federal Law restricts this device to sale by or on the order of a physician.
	Consult Instructions for Use. The Instructions for Use are provided in electronic form (e-labelling).

Table 1: Symbols Glossary

1.2 Safety Information Marking

WARNING

Non-compliance may result in serious injuries, serious deterioration of the general condition or the death of the patient, user, or a third party.

NOTICE

Product damage or other damage may occur in case of non-compliance.

1.3 Additional Information

This document is available in electronic form on the manufacturer's website. If required, a printed copy of this document can be requested from the manufacturer.

Download link for these Instructions for Use: ¹⁾	www.kurzmed.com/en/ifu/tym8.html
Download link for the processing instructions: ¹⁾	https://www.kurzmed.com/en/ifu/reprocessing.html
International addresses:	https://www.kurzmed.com/en/contact.html

¹⁾ Updated on an ongoing basis. Other language versions are also available there.

1.4 Safety-related Changes

Document number	Edition date	Safety-related Changes
0005960_01	2024-10	Complete revision
0005960_02	2024-11	None
0005960_03	2026-02	None

2 Important Safety Information

⚠ WARNING

- Before using the product: Read the Instructions for Use for the product and for all products used in combination. Follow and save the Instructions for Use. Otherwise there are risks for the health of your patient.
- Do not modify the product. Otherwise there are risks to the health of your patient.

ATTENTION: In case that any serious incident has occurred in relation to the device the incident should be reported to the manufacturer and to the competent authority of the Member State in which the user and/or patient is established.

3 Product Codes / REF

[▶ Specifications, page 13]

4 Scope of Delivery

[▶ Specifications, page 13]

5 Packaging and Sterility

KURZ Precise Cartilage Knife Set	The product is not sterile. Packaging: Bag with ziplock + outer packaging (folding box)
Cartilage Forceps Schimanski Design	The product is not sterile. Packaging: Bag with ziplock + outer packaging (folding box)
Cartilage Punch Set	The product is not sterile. Packaging: Bag with ziplock + outer packaging (folding box)
KURZ Precise Blades (accessories / disposable materials)	The product is sterile (sterilized by radiation).

6 Product Description

6.1 General Information

6.1.1 KURZ Precise Cartilage Knife Set



Illustration 1: KURZ Precise (cartilage knife set), KURZ Precise Blade

- A Cartilage knife: Cutting block (two parts)
- B Blade holder (two parts), here with blade; including screw for connecting
- C Cartilage knife: Nut
- D Tray KURZ Precise (instrument tray)
- E Blade (accessories / disposable materials)
- F Tray Stainless Steel (container for distance plates)
- G Distance plates (thickness: 0.1 mm/0.2 mm/0.3 mm) for creating cartilage discs of defined thickness

Available as accessories: 1 mm distance plate for pressing the fascia. [▶ Specifications, page 13]

6.1.2 Cartilage Punch Set

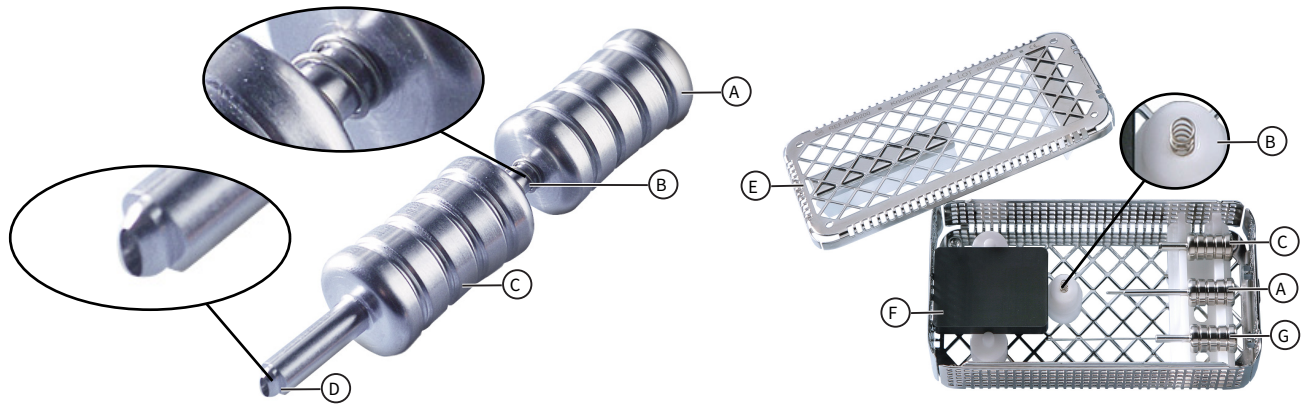

Illustration 2: Cartilage Punch Set

- A Part 1: Punch part with circular end
- B Spring
- C Part 2: Punch part with oval end
- D Oval end
- E Instrument tray
- F POM cutting board
- G Part 3: Ejector (longest part)

6.1.3 Cartilage Forceps Schimanski Design

Cartilage Forceps Schimanski Design : [▶ Specifications, page 13]

6.2 Structure and Operation

KURZ Precise Cartilage Knife Set in conjunction with the blade (accessories / disposable materials)	A cutting tool used for holding of graft material (cartilage or fascia), cutting of cartilage slices into a range of pre-defined thicknesses, compression of fascia.
Cartilage Forceps Schimanski Design	A tool designed to grasp and hold cartilage securely during cutting.
Cartilage Punch Set	A handheld tool which uses mechanical force to cut cartilage grafts of a pre-defined shape.

6.3 Materials

[▶ Specifications, page 13]

Not made with natural rubber (latex).

No products made with natural rubber (latex) are used in the production process.

6.4 Accessories

KURZ Precise Cartilage Knife Set	KURZ Precise Blades (not included in scope of delivery) 0.1/0.2/0.3 mm distance plates 1 mm distance plate, for pressing fascia (not included in scope of delivery) [▶ Specifications, page 13]
Cartilage Forceps Schimanski Design	No accessories available.
Cartilage Punch Set	No accessories available.

6.5 Other Devices to be Used in Combination with the Device

With the exception of the main product used (KURZ tympanoplasty prostheses), the cartilage preparation instruments are not intended for use in conjunction with other products.

7 Intended Use

7.1 Intended Purpose

<p>KURZ Precise Cartilage Knife Set with blade (accessories / disposable materials)</p>	<p>The KURZ Precise Cartilage Knife Set is a passive, reusable device which is used intraoperatively and non-invasively to cut cartilage into defined slices for implantation during a tympanoplasty procedure in combination with the KURZ Precise Blades. The KURZ Precise Cartilage Knife Set is used for intraoperative and non-invasive compression of fascia.</p> <p>KURZ Precise blades: The KURZ Precise Blades are passive, sterile, single use devices which are used intraoperatively and non-invasively to cut cartilage in combination with the KURZ Precise Cartilage Knife Set.</p> <p>Tray KURZ Precise: The Tray KURZ Precise is a reusable device used to hold the KURZ Precise during transport, sterilization and storage.</p> <p>Tray Stainless Steel: The Tray Stainless Steel is a reusable device used to hold the Distance Plates during sterilization and storage.</p>
<p>Cartilage Forceps Schimanski Design</p>	<p>The Cartilage Forceps are a passive, reusable device which is used intraoperatively and non-invasively to hold cartilage intended to be cut into slices for implantation during a tympanoplasty procedure with KURZ Tympanoplasty prostheses.</p>
<p>Cartilage Punch Set</p>	<p>The Cartilage Punch is a passive, reusable device which is used intraoperatively and non-invasively to punch cartilage slices into defined ovals with a center perforation for implantation during a tympanoplasty procedure with KURZ Total Tympanoplasty prostheses with a circular hollow stem.</p> <p>Tray Cartilage Punch: The Tray Cartilage Punch is a reusable device used to hold the KURZ Cartilage Punch during transport, sterilization and storage.</p>

7.2 Indications

According to the main device used (KURZ Tympanoplasty Prostheses).

7.3 Contraindications

According to the main device used (KURZ Tympanoplasty Prostheses).

7.4 Patient Target Group

According to the main device used (KURZ Tympanoplasty Prostheses).

7.5 Intended User

The intended user is a physician with experience in treating similar cases with this product or with comparable products or a physician with the following specialty:

- ENT (otorhinolaryngology)

7.6 Expected Lifetime

<p>KURZ Precise Cartilage Knife Set</p>	<p>Frequent processing has little impact on these instruments. The end of the product lifetime is usually based on wear and tear as well as damage from use. Please refer to the processing instructions.</p>
<p>KURZ Precise Blades (accessories / disposable materials)</p>	<p>Single-use product - lifetime corresponds to the duration of the procedure.</p>
<p>Cartilage Forceps Schimanski Design</p>	<p>Frequent processing has little impact on these instruments. The end of the product lifetime is usually based on wear and tear as well as damage from use. Please refer to the processing instructions.</p>
<p>Cartilage Punch Set</p>	<p>Frequent processing has little impact on these instruments. The end of the product lifetime is usually based on wear and tear as well as damage from use. Please refer to the processing instructions.</p>

7.7 Intended Place of Use

- Operating theatre

It is the responsibility of the user to decide on a case-by-case basis which precautions must be taken for any complications that may arise.

8 Expected Clinical Benefit

According to the main device used (KURZ Tympanoplasty Prostheses).

9 Possible Complications and Side Effects

According to the main device used (KURZ Tympanoplasty Prostheses).

10 Combining with Other Procedures

Does not apply.

11 Shelf Life and Storage

Store the product in a dry place and protect it from sunlight.

12 Processing

KURZ Precise Blades (accessories/consumables):

⚠ WARNING

- Single use product: Do not process (e.g., clean, disinfect, sterilize), resterilize or reuse the product. This is the only way to ensure the product is germ-free and functional. Due to the mechanical properties of the product, processing or resterilization could lead to material degradation.

KURZ Precise Cartilage Knife Set, cartilage knife tweezers, cartilage punch:

⚠ WARNING

- The product is not sterile. Process the product before first and any further application. This is the only way to ensure the product is germ-free and functional. Process in accordance with the processing instructions document. [▶ Additional Information, page 3]

13 Application Instructions

⚠ WARNING

- Do not use the product if the packaging or the product is damaged or expired. This is the only way to ensure the product is germ-free and functional.
- Only remove the product from the packaging/sterilisation container immediately before use. If the product is removed from the packaging/sterilisation container, observe the relevant hygiene regulations. Otherwise there are risks to the health of your patient.

Ensure the presence of hygienic / sterile conditions needed for the intervention.

ATTENTION: Also observe the instructions for use of the KURZ partial/total prosthesis used.

13.1 KURZ Precise Cartilage Knife

13.1.1 Create cartilage graft with a defined thickness

13.1.1.1 Assembling the Cutting Block



1. Prepare the cutting block parts: The screw on the lower part of the cutting block and the KURZ logo on the upper part (with hole) are pointing upwards.



2. Position the upper part of the cutting block on the lower part of the cutting block so that the screw protrudes through the hole and the KURZ logo on the upper part points upwards.
3. Rotate the upper and lower part by 90° in relation to each other. Loosely screw the nut onto the screw. The collar of the nut is facing downwards.

13.1.1.2 Preparing the Blade and Blade Holder

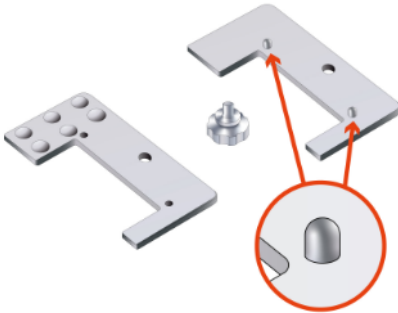

1. Remove the screw from the blade holder. Position the blade holder part featuring pins (part 1) on an even surface so that the two pins are facing upwards.



2. Carefully remove the blade from the sterile packaging.
3. Position the blade on part 1 of the blade holder so that the pins are exactly in the recesses of the blade.



4. Position the blade holder part without pins (part 2) accurately onto part 1 and the blade.
5. Secure both blade holder parts to each other with the screw. In this process, initially guide the screw through part 2 at the top. The blade has now been secured in the blade holder. The cutting edge protrudes 1 mm beyond the blade holder.

13.1.1.3 Preparing the Cartilage Graft

Cutting without a distance plate will produce a cartilage graft with a thickness of 0.7 mm. Use the distance plates to create thinner specimens. [▶ Creating thinner cartilage grafts: Using a Distance Plate, page 9]

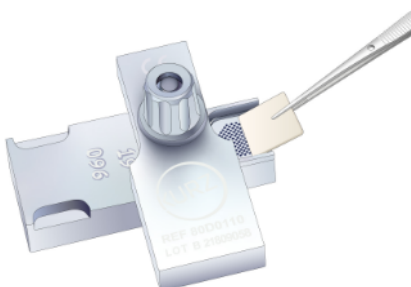

1. Place a suitable cartilage graft (max. 12.6 x 12.6 mm) in the recess on the lower part of the cutting block with the perichondrium facing upwards.



2. Rotate the upper part of the cutting block until it is flush with the lower part. Tighten the nut to secure the cutting block in this position.
ATTENTION: Tighten the nut to the extent that the two cutting block parts and the cartilage are secured, but make sure that the cartilage is not crushed.



3. Position the cutting block upright. Remove any protruding cartilage using the blade.
ATTENTION: Ensure that the protruding cartilage is completely removed.

13.1.1.4 Cutting the Cartilage Graft

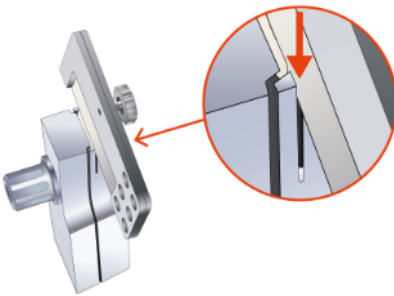

1. Position the blade in the guide on the lower part and cut through the cartilage by moving the blade like a saw. Initially leave the blade in the guide.



2. Put down the cutting block, loosen the nut and rotate the upper part of the cutting block by 90°.
3. Remove the cartilage disc on the blade (perichondrium/cartilage disc with undefined thickness) using tweezers.

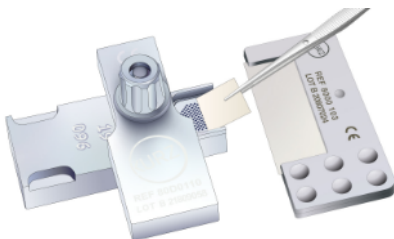

4. Remove the blade. The cartilage graft with a defined thickness is on the lower part of the cutting block. Remove the cartilage graft using tweezers.

The cartilage graft is now ready for use or can be further processed using distance plates to make the cartilage graft thinner.

13.1.1.5 Creating thinner cartilage grafts: Using a Distance Plate

Create cartilage grafts with a defined thickness (0.1 - 0.6 mm) using the distance plates. For this purpose, use the individual or a combination of distance plates.

The thickness of the cartilage grafts corresponds to 0.7 mm minus the thickness of the distance plates used.

Recess in cutting block
= 0.7 mm

Example:
Cartilage graft = 0.5 mm
Distance plate = 0.2 mm

Illustration 3: Cartilage graft thickness = 0.7 mm minus the thickness of the distance plates

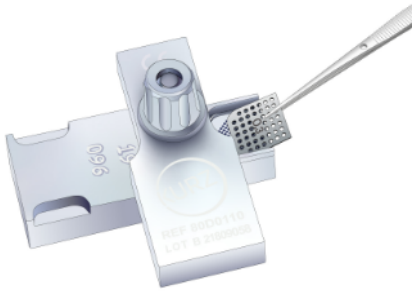

1. Place the desired distance plate in the recess in the lower part of the cutting block.
2. Repeat the steps for preparing the cartilage graft and for cutting the cartilage graft.
[▶ Preparing the Cartilage Graft, page 8]
[▶ Cutting the Cartilage Graft, page 9]

13.1.2 Pressing the Fascia

ATTENTION: The 1 mm distance plate (REF 8000105, sold separately) is required to press fascia. [▶ Specifications, page 13]

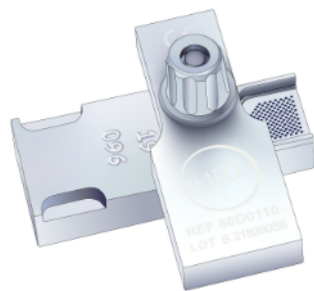

1. Assemble the cutting block. [▶ Assembling the Cutting Block, page 7]



2. Place the 1 mm distance plate in the recess in the lower part of the cutting block.
3. Place the fascia on the distance plate.



4. Rotate the upper part of the cutting block until it is flush with the lower part. Tighten the nut to secure the cutting block in this position and press the fascia.



5. Put down the cutting block, loosen the nut and rotate the upper part of the cutting block by 90°.
6. The fascia is on the distance plate. Remove the fascia with tweezers.

13.2 Cartilage Forceps Schimanski Design: Holding the Cartilage

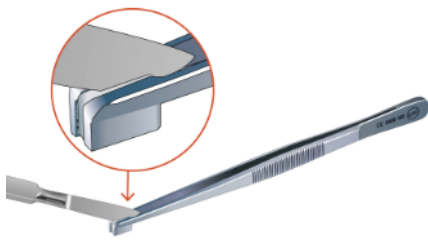

1. Hold the cartilage with tweezers to cut it with a scalpel.

13.3 Cartilage punch: Creating a Cartilage Shoe

Cartilage shoe: Cartilage graft of defined size and shape, with circular hole in the centre. The cartilage shoe is used to stabilise KURZ total prostheses with circular, hollow shaft on the stapes footplate. [▶ Specifications, page 13]

The manufacturer recommends cutting the cartilage graft to a defined thickness using the KURZ Precise Cartilage Knife before creating the cartilage shoe. [▶ Create cartilage graft with a defined thickness, page 7]

ATTENTION: Always punch on the cutting board. Exclusively use the cutting board for punching.

1. Take the punch part with the circular end (part 1). Place the spring on the shaft.

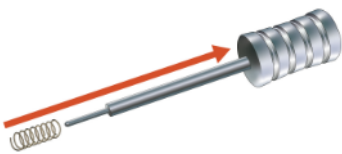

2. Place the punch part with the oval end (part 2) on the shaft. The cartilage punch is ready for use.



3. Place the cartilage graft on the cutting board.
4. Position the tip of the cartilage punch perpendicular to the cartilage graft. Ensure that the tip is fully positioned on the cartilage graft.
5. Hold the cartilage punch at the lower part (part 2) and apply pressure to the cartilage graft. In this process, slightly move the end of the cartilage punch in circles to cut the outline of the cartilage shoe.



ATTENTION: Completely cut through the cartilage graft.

6. Hold the cartilage punch upright and secure its position. Grasp the cartilage punch on the upper part (part 1) and apply pressure to part 1 to punch the hole in the centre of the cartilage shoe.





7. The cartilage shoe is now ready for use. For this purpose, grasp the cartilage shoe with tweezers and position it on the stapes footplate.

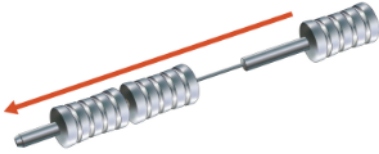

8. Remove residue from the cartilage punch. For this purpose, insert the ejector (part 3) into the hollow shaft of the cartilage punch and push the residue out of the shaft.

14 Disposal

⚠ WARNING

- The product was in contact with potentially infectious substances of human origin. Clean/pack the product for disposal according to the specific contamination risk. Dispose of the product in accordance with procedures for hazardous waste in hospitals. Otherwise there is a risk of infection for the user and for third parties.

⚠ CAUTION

- The product has points / sharp edges. For disposal, pack the product in a suitable stable container. Otherwise there is a risk of infection for the user and for third parties.

Disposal must be in accordance with national disposal regulations and pursuant to the corresponding risk class.

15 Warranty

The reliability of the product's material and design at the time of shipment is guaranteed. The manufacturer does not know either the diagnosis of the patient or the nature of the application and has no influence on the conditions under which the product is used. The storage conditions after delivery of the product are also beyond the manufacturer's area of responsibility.

Due to biological and individual differences, no product is 100% effective under all circumstances.

Therefore, the manufacturer cannot guarantee a positive effect or the absence of negative effects for product application. The medical staff must use the product on the basis of their medical training and experience, and they are responsible for correct application.

The warranty (repair or replacement) applies only if the product is used in accordance with these Instructions for Use (for instruments, particularly with regard to handling, cleaning, sterilization and maintenance); the warranty period starts on the delivery date.

If you have reason to believe that a new product is faulty, please contact the Customer Service in writing immediately and provide as detailed a description as possible of the fault, the REF (product code), and the LOT (batch code) and/or series number. All allegedly defective products must be returned to us for inspection. Instruments have to be completely cleaned and sterilized, appropriate documentation must be enclosed with the return.

If the manufacturer finds that despite all due care the product was defective at the time of delivery, he will repair the product or replace it promptly. If repair or replacement of the product is not possible, the buyer has the right to cancel the purchase or to reduce the payment, but by a maximum of the purchase price amount.

Additional claims or those not mentioned here due to defect, and other claims regardless of the legal reason, including those based on illegal acts and for compensation of immaterial damages against the manufacturer, his agents, dealers and suppliers, are excluded unless existing law is contrary to the liability exclusion, e.g. in cases of intent or gross negligence or in the event of physical injury.

All claims based on the consequences of non-compliance with the Instructions for Use, including specified indications, contraindications, warnings, instructions, application, storage and off-label use, as well as the consequences of a combination with third-party products are excluded.

Furthermore, all claims that result from the use of products that have expired, or were used despite the obvious damage to the packaging, or resterilized and/or recycled contrary to the Instructions for Use, are excluded.

No one is allowed to change the above conditions, make further warranty or liability declarations, or guarantee any properties that surpass those specified in the Instructions.

16 Specifications

16.1 KURZ Precise Cartilage Knife

16.1.1 KURZ Precise Cartilage Knife Set

Scope of Delivery	REF	Material
1 x blade holder 1 x screw for blade holder 1 x cutting block, two parts 1 x nut for cutting block 3 x distance plates (thickness: 0.1 mm/ 0.2 mm/0.3 mm) 1 x Tray KURZ Precise, including 1 x Tray Stainless Steel (con- tainer for distance plates) 1 x processing instructions	8000 155	Stainless steel, plastic (POM, insert mat)
ATTENTION: Use of additional blades (accessories) is mandatory.		

16.1.2 Accessories, Disposable Materials and Spare Parts

Item	REF	Material	Properties
Blades, 10x	8000 140	Stainless steel	Sterile, individually packed
Distance plate, 1 mm for pressing fascia	8000 105	Stainless steel	Non-sterile, reusable
Distance plate, 3x Thickness: 0,1 / 0,2 / 0,3 mm	8000 102	Stainless steel	Non-sterile, reusable
Blade holder, including M3 screw	8000 103	Stainless steel	Non-sterile, reusable
M3 screw for blade holder	8000 190	Stainless steel	Non-sterile, reusable
Cutting block, including M6 nut	8000 110	Stainless steel	Non-sterile, reusable
M6 nut for cutting block	8000 191	Stainless steel	Non-sterile, reusable
Tray KURZ Precise , including insert plate and Tray Stainless Steel (con- tainer for distance plates)	8000 177	Stainless steel Plastic (POM, insert plate)	Non-sterile, reusable
Tray Stainless Steel	8000 124	Stainless steel	Non-sterile, reusable

16.2 Cartilage Forceps Schimanski Design

Scope of Delivery	REF	Material
1 x Cartilage Forceps Schimanski Design 1 x processing instructions	8000 193	Stainless steel

16.3 Cartilage Punch

16.3.1 Cartilage punch set

Scope of Delivery	REF	Material
1 x cartilage punch, including punch part with circular end,	8000 200	Stainless steel, plastic (POM, cutting board)

Scope of Delivery	REF	Material
punch part with oval end, spring, ejector 1 x POM cutting board 1 x instrument tray 1 x processing instructions		
For creating a cartilage shoe for the following KURZ total prostheses: TTP Tuebingen AERIAL Total, Duesseldorf AERIAL Total, Munich LMU AERIAL Total, Malleus Notch Total, TTP VARIAC System Total		

16.3.2 Spare Parts

Item	REF	Material	Properties
Cartilage punch instrument tray, including insert plate	8000 176	Stainless steel Plastic (POM, insert plate)	Non-sterile, reusable
Spring	8000 198	Stainless steel	Non-sterile, reusable
POM cutting board	8000 207	Plastic (POM)	Non-sterile, reusable